

SANYO

No. 2796C

LC66506B, 66508B

6K-Byte/8K-Byte ROM-Contained
Single-Chip 4-Bit Microcomputer
for Control-Oriented Applications

General Description

The LC66506B, 66508B are 64-pin package type CMOS 4-bit single-chip microcomputers. They contain a ROM, a RAM, I/O ports, a dual 8-bit serial interface, a 4-channel comparator input, a dual 3-level input port, a 12-bit timer, an 8-bit timer, and provide 11 interrupt sources with 8 vector addresses.

Features

- (1) On-chip 6K-byte/8K-byte ROM, 512x4-bit RAM
- (2) Instruction set with 127 instructions extended from that of the LC6500 series
- (3) I/O ports ----- 58 pins
- (4) 8-bit serial interface ----- 2 lines (16-bit cascade connection available)
- (5) Minimum instruction cycle time ----- 0.92 μ s (4.3MHz external clock input mode)
- (6) Powerful timer function and prescaler
12-bit timer-used interval timer, event counter, pulse width measurement, burst pulse output
8-bit timer-used interval timer, event counter, PWM output, burst pulse output
12-bit prescaler-used time base function
- (7) Powerful 11-source 8-vector interrupt function
External interrupt: 6 sources, 3 vector addresses
Internal interrupt: 5 sources, 5 vector addresses (timer: 2 sources, serial I/O: 2 sources, prescaler)
- (8) Flexible I/O function
Comparator input, 3-level input, 20mA drive output, 15V breakdown voltage, pull-up/open drain selectable by option
- (9) Runaway detection function (option)
- (10) 8-bit input/output function
- (11) HALT/HOLD mode-used power-down function
- (12) Package: DIP64S, QFP64A (QIP64A)
- (13) Evaluation LSI: LC66599 (evaluation chip) + EVA850/800-TB665XX, LC66PG5XX (piggyback)
LC66E516 microcontroller with built-in EPROM, LC66P516 microcontroller with built-in one-time programmable ROM.

Note: The LC66506B, 66508B are different from the LA66506A, 66508A in the external constants for RC

Series Lineup

Type No.	Pins	ROM capacity	RAM capacity	Package	Remark
LC66304A/306A/308A	42,48	4K/6K/8KB	512W	DIP42S, QFP48E	Available
LC66354A/356A/358A	42,48	4K/6K/8KB	512W	DIP42S, QFP48E	Available
LC66354S/356S/358S	44	4K/6K/8KB	512W	QFP44M	Under development
LC66E308	42,48	EPROM 8KB	512W	DIC42S, QFC48 with window	Available
LC66P308	42,48	OTPROM 8KB	512W	DIP42S, QFP48E	Available
LC66404A/406A/408A	42,48	4K/6K/8KB	512W	DIP42S, QFP48E	Available
LC66E408	42,48	EPROM 8KB	512W	DIC42S, QFC48 with window	Available
LC66P408	42,48	OTPROM 8KB	512W	DIP42S, QFP48E	Available
LC66506B/508B/512B/516B	64	6K/8K/12K/16KB	512W	DIP64S, QFP64A	Available
LC66556A/558A/562A/566A	64	6K/8K/12K/16KB	512W	DIP64S, QFP64E	Available
LC66354B/356B/358B	42,48	4K/6K/8KB	512W	DIP42S, QFP48E	Available
LC66556B/558B	64	6K/8K	512W	DIP64S, QFP64E	Under development
LC66562B/566B	64	12K/16KB	512W	DIP64S, QFP64E	Available
LC66E516	64	EPROM 16KB	512W	DIC64S, QFC64 with window	Available
LC66P516	64	OTPROM 16KB	512W	DIP64S, QFP64E	Available

SANYO Electric Co., Ltd. Semiconductor Business Headquarters
TOKYO OFFICE Tokyo Bldg., 1-10, 1 Chome, Ueno, Taito-ku, TOKYO, 110 JAPAN

Package Dimensions 3071

(unit: mm)

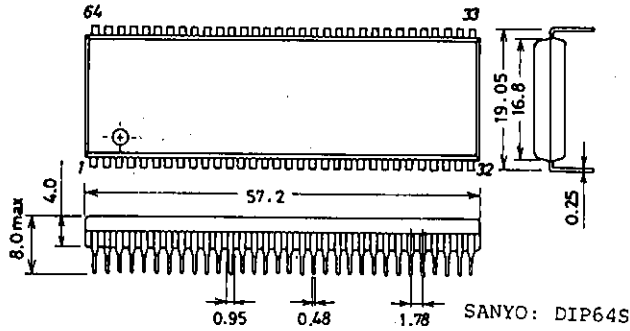

Pin Assignment

DIP64S

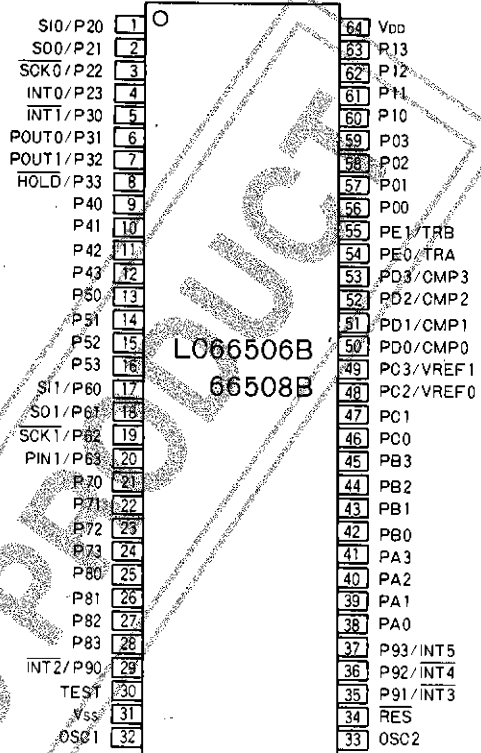

Package Dimensions 3057

(unit: mm)

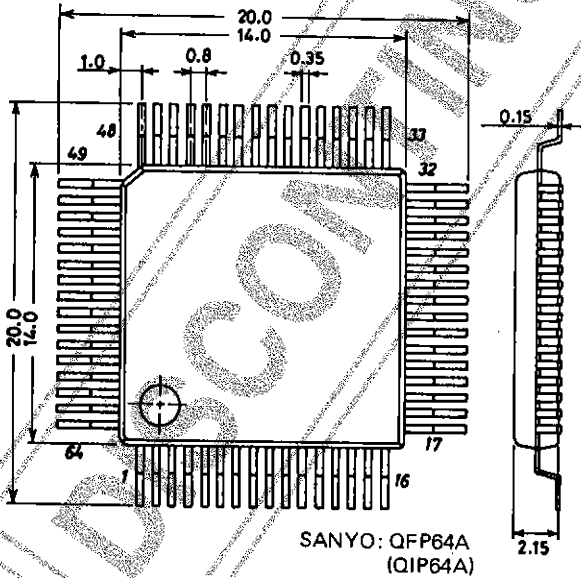

Pin Assignment

QIP64

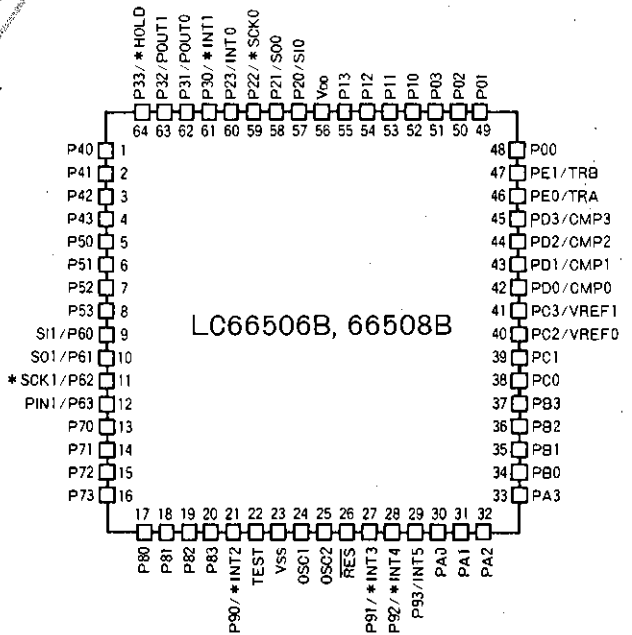

Note) Reflow soldering is recommended for QFP (QIP) packages.
Please consult your local representative for information on solder-bath immersion of the device.

System Block Diagram

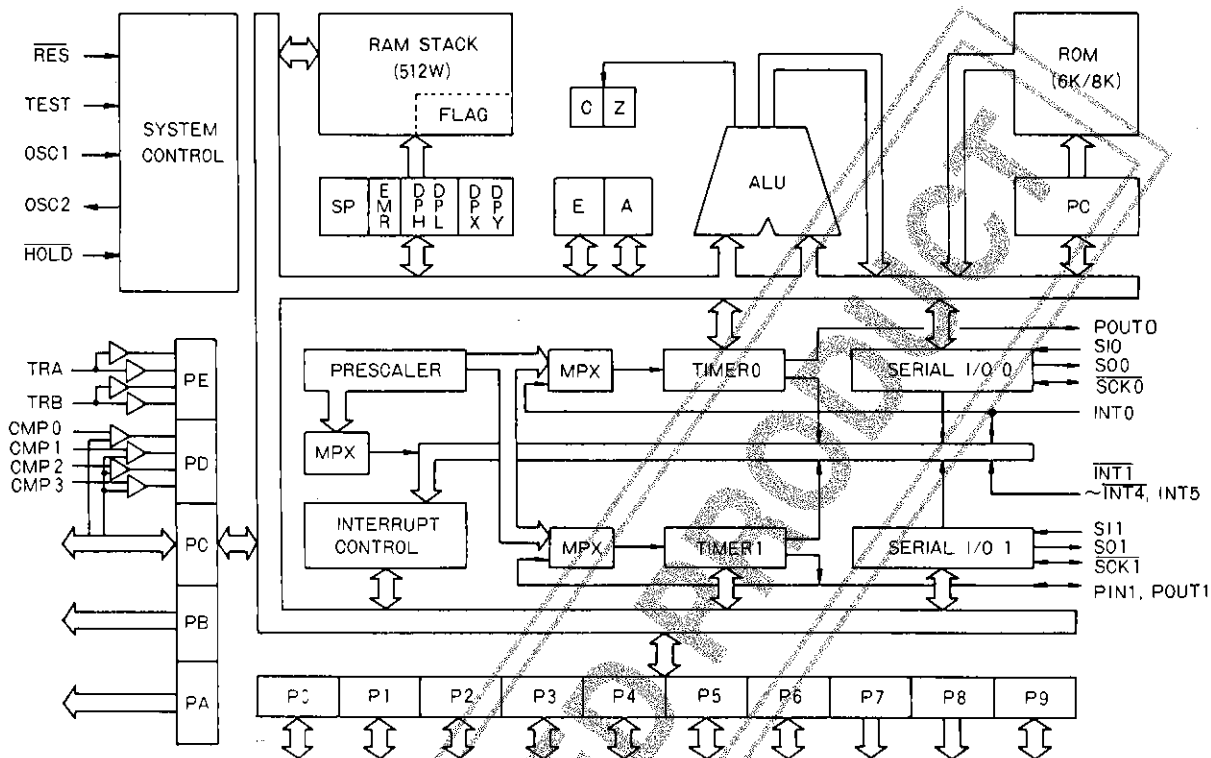

DISCONTINUED

Pin Description

Pin Name	I/O	Functions	Output Driver Type	Option	During Reset
P00 P01 P02 P03	I/O	Input/output common port P00 to P03 <ul style="list-style-type: none"> 4-bit and single-bit input/output P00 to P03: Provided with HALT mode control function 	<ul style="list-style-type: none"> Pch: Pu MOS type Nch: Small sink current type 	<ul style="list-style-type: none"> With Pu MOS or Nch OD output Output level during reset 	H or L (option)
P10 P11 P12 P13	I/O	Input/output common port P10 to P13 <ul style="list-style-type: none"> 4-bit and single-bit input/output 	<ul style="list-style-type: none"> Pch: Pu MOS type Nch: Small sink current type 	<ul style="list-style-type: none"> With Pu MOS or Nch OD output Output level during reset 	H or L (option)
P20/SIO P21/SO0 P22/SCK0 P23/INT0	I/O	Input/output common port P20 to P23 <ul style="list-style-type: none"> 4-bit and single-bit input/output P20: Common with serial input SIO P21: Common with serial output SO0 P22: Common with serial clock SCK0 P23: Common with INT0 interrupt and timer 0-used event count, pulse width measurement input 	<ul style="list-style-type: none"> Pch: CMOS type Nch: Small sink current type +15V breakdown voltage at Nch OD configuration 	<ul style="list-style-type: none"> CMOS or Nch OD output 	H
P30/INT1 P31/POUT0 P32/POUT1	I/O	Input/output common port P30 to P32 <ul style="list-style-type: none"> 3-bit and single-bit input/output P30: Common with INT1 interrupt request P31: Common with burst pulse output from timer 0 P32: Common with burst pulse output, PWM output from timer 1 	<ul style="list-style-type: none"> Pch: CMOS type Nch: Small sink current type +15 breakdown voltage at Nch OD configuration 	<ul style="list-style-type: none"> CMOS or Nch OD output 	H
P33/HOLD	I	HOLD mode control input <ul style="list-style-type: none"> The HOLD mode is entered by executing the HOLD instruction at $\overline{\text{HOLD}}=\text{L}$. The CPU is restarted by setting the $\overline{\text{HOLD}}$ to H level at the HOLD mode. Usable as input port P33 with P30 to P32 Even if the $\overline{\text{RES}}$ is brought to L level when the P33/HOLD is at L level, the CPU is not reset. So this pin must be H level when VDD has risen to a point where the CPU can operate properly. 			

Continued on next page.

LC66506B,66508B

Continued from preceding page.

Pin Name	I/O	Functions	Output Driver Type	Option	During Reset
P40 P41 P42 P43	I/O	Input/output port P40 to P43 • 4-bit and single-bit input/output • 8-bit input/output with P50 to P53 • 8-bit output of ROM data with P50 to P53	• Pch: Pu MOS type • Nch: Small sink current type	• With Pu MOS or Nch OD output	H
P50 P51 P52 P53	I/O	Input/output port P50 to P53 • 4-bit and single-bit input/output • 8-bit input/output with P40 to P43 • 8-bit output of ROM data with P40 to P43	• Pch: Pu MOS type • Nch: Small sink current type	• With Pu MOS or Nch OD output	H
P60/S11 P61/SO1 P62/SCK1 P63/PIN1	I/O	Input/output common port P60 to P63 • 4-bit and single-bit input/output • P60: Common with serial input S11 • P61: Common with serial output SO1 • P62: Common with serial clock SCK1 • P63: Common with event counter input of timer 1	• Pch: CMOS type • Nch: Small sink current type • +15V breakdown voltage at Nch OD configuration	• CMOS or Nch OD output	H
P70 P71 P72 P73	O	Output-only port P70 to P73 • 4-bit and single-bit output • When an input instruction is executed, the contents of the output latch are input.	• Pch: Pu MOS type • Nch: Medium sink current type • +15V breakdown voltage at Nch OD configuration	• With Pu MOS or Nch OD output	H
P80 P81 P82 P83	O	Output-only port P80 to P83 • 4-bit and single-bit output • When an input instruction is executed, the contents of the output latch are input. • Pch OD output option available	• Pch: CMOS type • Nch: Small sink current type	• CMOS or Pch OD output • Output level during reset	H or L (option)
P90/INT2 P91/INT3 P92/INT4 P93/INT5	I/O	Input/output common port P90 to P93 • 4-bit and single-bit input/output • P90: Common with INT2 interrupt request • P91: Common with INT3 interrupt request • P92: Common with INT4 interrupt request • P93: Common with INT5 interrupt request	• Pch: CMOS type • Nch: Small sink current type	• CMOS or Nch OD output	H

Continued on next page.

LC66506B,66508B

Continued from preceding page.

Pin Name	I/O	Functions	Output Driver Type	Option	During Reset
PA0 PA1 PA2 PA3	O	Output-only port PA0 to PA3 •4-bit and single-bit output •When an input instruction is executed, the contents of the output latch are input.	•Pch: Pu MOS type •Nch: Medium sink current type •+15V breakdown voltage at Nch OD configuration	•With Pu MOS or Nch OD output	H
PB0 PB1 PB2 PB3	O	Output-only port PB0 to PB3 •4-bit and single-bit output •When an input instruction is executed, the contents of the output latch are input.	•Pch: Pu MOS type •Nch: Medium sink current type	•With Pu MOS or Nch OD output	H
PC0 PC1 PC2/VREF0 PC3/VREF1	I/O	Input/output common port PC0 to PC3 •4-bit and single-bit input/output •PC2: Common with VREF0 comparator comparison voltage pin •PC3: Common with VREF1 comparator comparison voltage pin	•Pch: CMOS type •Nch: Small sink current type	•CMOS or Nch OD output	H
PD0/CMP0 PD1/CMP1 PD2/CMP2 PD3/CMP3	I	Input-only port PD0 to PD3 •The comparator input is software-selectable. The comparison voltage of PD0 is VREF0. The comparison voltage of PD1 to PD3 is VREF1. The comparator is specified in units of PD0, PD1, (PD2, PD3).			Normal input
PE0/TRA PE1/TRB	I	Input-only port •The 3-level input port is software-selectable.			Normal input
OSC1 OSC2	I O	Pins for externally connecting R, C or a ceramic resonator for system clock generation. For the external clock mode, the OSC2 pin is left open and the OSC1 pin is used for input.		•Ceramic resonator OSC, RC OSC, or external clock	
RES	I	System reset input pin •When the $\overline{\text{RES}}$ is brought to L level at P33/HOLD=H, the CPU is initialized.			
TEST	I	CPU test pin Connected to V _{SS} at the operating mode			
VDD VSS		Power supply pins			

Remarks: Output with Pu MOS ----- Output with pull-up MOS transistor
 CMOS output ----- Complementary output
 OD output ----- Open drain output

User Options

(1) Options of ports 0, 1, 8 output level during reset

For input/output ports 0, 1, 8, either of the following two output levels may be selected in a group of 4 bits during reset by option.

Option Name	Conditions, etc.
1. Output during reset: "H" level	All of 4 bits of ports 0, 1, 8
2. Output during reset: "L" level	All of 4 bits of ports 0, 1, 8

(2) Oscillator Circuit Options

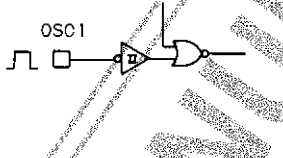
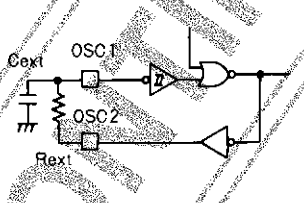
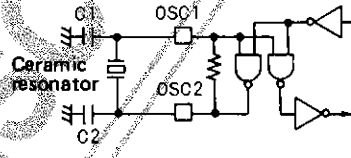
Option Name	Circuit	Conditions, etc.
1. External clock		• Input: Schmitt type
2. 2-pin RC OSC		• Input: Schmitt type
3. Ceramic resonator OSC		

(3) Watchdog timer option

The presence or absence of the runaway detection function (watchdog timer) may be selected by option.

(4) Options of port output configuration

i) For each port of P0, P1, P2, P3 (except P33/HOLD), P4, P5, P6, P7, P9, PA, PB, PC, either of the following two output configurations may be selected by option (in bit units).

Option Name	Circuit	Conditions, etc.
1. Open drain type output		P7, PA, PB: Output only P2, P3, P6, P9: Schmitt input
2. Output with pull-up resistance		P7, PA, PB: Output only P2, P3, P6, P9: Schmitt input CMOS output (P2, P3, P6, P9, PC) or Pu MOS output (P0, P1, P4, P5, P7, PA, PB) is selected according to Pch Tr drive capacity.

ii) For P8, either of the two options may be selected (in bit units).

Option Name	Circuit	Conditions, etc.
1. Open drain output		
2. Output with pull-down resistance		

iii) The comparator input of PD and the 3-level input of PE are software-selectable.

LC66506B,66508B

(1) Absolute Maximum Ratings at Ta=25°C, VSS=0V

Parameter	Symbol	Applicable Pins, Remarks	Conditions	Limits	Unit	Note
Maximum Supply Voltage	VDD max	VDD		-0.3 to +7.0	V	
Input Voltage	VIN(1)	P2,P3(except P33/HOLD), P6		-0.3 to +15.0	V	1
	VIN(2)	Other inputs		-0.3 to VDD+0.3	V	2
Output Voltage	VOUT(1)	P2,P3(except P33/HOLD), P6,P7,PA		-0.3 to +15.0	V	1
	VOUT(2)	Other outputs		-0.3 to VDD+0.3	V	2
Output Current per Pin	I _{ON} (1)	P0,P1,P2,P3(except P33/HOLD),P4,P5,P6,P8,P9, PC		4	mA	3
	I _{ON} (2)	P7,PA,PB		20	mA	3
	-I _{OP} (1)	P0,P1,P4,P5,P7,PA, PB		2	mA	4
	-I _{OP} (2)	P2,P3(except P33/HOLD), P6,P8,P9,PC		4	mA	4
Total Pin Current	ΣI _{ON} (1)	P2,P3(except P33/HOLD), P4,P5,P6,P7,P8		75	mA	3
	ΣI _{ON} (2)	P0,P1,P9,PA,PB,PC		75	mA	3
	-ΣI _{OP} (1)	P2,P3(except P33/HOLD), P4,P5,P6,P7,P8		25	mA	4
	-ΣI _{OP} (2)	P0,P1,P9,PA,PB,PC		25	mA	4
Allowable Power Dissipation	Pd max	Ta=-30 to +70°C	DIP-64S (QFP-64)	600(430)	mW	5
Operating Temperature	T _{opr}			-30 to +70	°C	
Storage Temperature	T _{stg}			-55 to +125	°C	

- (Note 1) Applicable only when the open drain output type is selected. If other type than the open drain output is selected, the specification indicated in the column for other pins applies.
- (Note 2) For OSC input/output, up to self OSC level is allowable.
- (Note 3) Sink current (applicable to PB only when the CMOS output type is selected)
- (Note 4) Source current (applicable to pins other than PB only when the pull-up output type or CMOS output type is selected)
- (Note 5) Reflow soldering is recommended for QFP packages.
Please consult your local representative for information on solder-bath immersion of the device.

(2) Allowable Operating Conditions at Ta=-30 to +70°C, VSS=0V unless otherwise specified

Parameter	Symbol	Applicable Pins	Conditions	Limits			Unit	Note	
				VDD(V)	min	typ			max
Operating Voltage	VDD	VDD			4.0	5.0	6.0	V	
Data Retention Voltage	VDD(H)	VDD	HOLD mode		1.8		6.0	V	
"H"-Level Input Voltage	V _{IH} (1)	P2,P3(except P33/HOLD), P6	Output Nch Tr OFF	4.0 to 6.0	0.75VDD		+13.5	V	1
	V _{IH} (2)	P33/HOLD,P9, RES OSC1	Output Nch Tr OFF	4.0 to 6.0	0.75VDD		VDD	V	2
	V _{IH} (3)	P0,P1,P4,P5,PC, PD,PE	Output Nch Tr OFF	4.0 to 6.0	0.7VDD		VDD	V	3
	V _{IH} (4)	PE	3-level input mode	4.0 to 6.0	0.8VDD		VDD	V	

Continued on next page.

Continued from preceding page.

Parameter	Symbol	Applicable Pins	Conditions	Limits			Unit	Note		
				V _{DD} (V)	min	typ			max	
"M"-Level Input Voltage	V _{IM}	PE	3-level input mode	4.0 to 6.0	0.4V _{DD}		0.6V _{DD}	V		
Common-Mode Input Voltage Range	V _{COMM}	PD, PC2, PC3	Comparator input mode	4.0 to 6.0	1.0		V _{DD} - 1.5	V		
"L"-Level Input Voltage	V _{IL} (1)	P2, P3 (except P33/HOLD), P6, P9, RES	Output Nch Tr OFF	4.0 to 6.0	V _{SS}		0.25V _{DD}	V	2	
	V _{IL} (2)	P33/HOLD		1.8 to 6.0	V _{SS}		0.25V _{DD}	V		
	V _{IL} (3)	P0, P1, P4, P5, PC, PD, PE, TEST	Output Nch Tr OFF	4.0 to 6.0	V _{SS}		0.3V _{DD}	V	3	
	V _{IL} (4)	PE	3-level input mode	4.0 to 6.0	V _{SS}		0.2V _{DD}	V		
Operating Frequency (Instruction Cycle Time)	f _{OP} (TCYC)			4.0 to 6.0	0.4 (10)		4.35 (0.92)	MHz (μs)		
External Clock Input Conditions	Frequency	f _{ext}	OSC1	See Fig. 1. The OSC1 is used for input and the OSC2 is left open. (OSC option: External clock input)	4.0 to 6.0	0.4		4.35	MHz	
	Pulse Width	textH textL		See Fig. 1. The OSC1 is used for input and the OSC2 is left open. (OSC option: External clock input)	4.0 to 6.0	70			ns	
	Rise/Fall Time	textR textF		See Fig. 1. The OSC1 is used for input and the OSC2 is left open. (OSC option: External clock input)	4.0 to 6.0			30	ns	
Self OSC Conditions	Ceramic Resonator OSC	OSC Frequency	f _{CF}	OSC1, OSC2	See Fig. 2.	4MHz	4.0 to 6.0	4.0		MHz
		OSC Stabilizing Period	t _{CFS}		Fig. 3	4MHz	4.0 to 6.0		10	ms
	External Constants for RC OSC	C _{ext} R _{ext}	OSC1, OSC2	See Fig. 4.		4.0 to 6.0		100 2.7	pF kΩ	

(Note 1) Applicable to pins of open drain type. For P33/HOLD, V_{IH}(2) applies.

P2, P3, P6 of CMOS output type cannot be used as input pin.

(Note 2) Applicable to pins of open drain type. P9 of CMOS output type cannot be used as input pin.

(Note 3) When PE is used for 3-level input, V_{IH}(4), V_{IM}, V_{IL}(4) apply. PC of CMOS output type cannot be used as input pin.

LC66506B,66508B

(3) Electrical Characteristics at Ta=-30 to +70°C, VSS=0V unless otherwise specified

Parameter	Symbol	Applicable Pins	Conditions	Limits			Unit	Note	
				VDD(V)	min	typ			max
"H"-Level Input Current	I _{IH} (1)	P2, P3 (except P33/HOLD), P6	V _{IN} =13.5V Output Nch Tr OFF	4.0to6.0			5.0	μA	1
	I _{IH} (2)	P0, P1, P4, P5, P9, PC, OSC1, RES, P33/HOLD (except PD, PE, PC2, PC3)	V _{IN} =VDD Output Nch Tr OFF	4.0to6.0			1.0	μA	1
	I _{IH} (3)	PD, PE, PC2, PC3	V _{IN} =VDD Output Nch Tr OFF	4.0to6.0			1.0	μA	1
"L"-Level Input Current	I _{IL} (1)	Inputs other than PD, PE, PC2, PC3	V _{IN} =VSS Output Nch Tr OFF	4.0to6.0	-1.0			μA	2
	I _{IL} (2)	PC2, PC3, PD, PE	V _{IN} =VSS Output Nch Tr OFF	4.0to6.0	-1.0			μA	2
"H"-Level Output Voltage	V _{OH} (1)	P2, P3 (except P33/HOLD), P6, P8, P9, PC	I _{OH} =-1mA	4.0to6.0	VDD-1.0			V	3
			I _{OH} =-0.1mA	4.0to6.0	VDD-0.5			V	3
	V _{OH} (2)	P0, P1, P4, P5, P7, PA, PB	I _{OH} =-200μA	4.5	2.4			V	4
			I _{OH} =-130μA	4.5to5.5	VDD-1.35			V	4
Output Pull-up Current	I _{PO}	P0, P1, P4, P5, P7, PA, PB	V _{IN} =VSS	6.0	-1.6			mA	4
"L"-Level Output Voltage	V _{OL} (1)	P0, P1, P2, P3, P4, P5, P6, P8, P9, PC (except P33/HOLD)	I _{OL} =1.6mA	4.0to6.0			0.4	V	5
	V _{OL} (2)	P7, PA, PB	I _{OL} =10mA	4.0to6.0			1.5	V	
Output OFF-State Leakage Current	I _{OFF} (1)	P2, P3, P6, P7, PA	V _{IN} =13.5V	4.0to6.0			5.0	μA	6
	I _{OFF} (2)	(Except P2, P3, P6, P7, P8, PA)	V _{IN} =VDD	4.0to6.0			1.0	μA	6
	I _{OFF} (3)	P8	V _{IN} =VSS	4.0to6.0	-1.0			μA	7
Comparator Offset Voltage	V _{OFF}	PD	V _{IN} =1.0V to VDD-1.5V	4.0to6.0		±50	±300	mV	
Schmitt Characteristics	Hysteresis Voltage	V _{HYS}	P2, P3, RES, P6, P9, OSC1 (RC, EXT)	4.0to6.0		0.1VDD		V	
	"H"-Level Threshold Voltage	V _{tH}			0.5VDD		0.75VDD	V	
	"L"-Level Threshold Voltage	V _{tL}			0.25VDD		0.5VDD	V	
RC OSC Frequency	f _{RC}	OSC1, OSC2	See Fig. 4 C=100pF±5% R=2.7kΩ±1%	4.0to6.0	2.0	3.0	4.0	MHz	

Continued on next page.

Continued from preceding page.

Parameter	Symbol	Applicable Pins	Conditions	Limits			Unit	Note						
				VDD(V)	min	typ			max					
Serial Clock	Cycle Time	tCKCY	SCK0, SCK1	Timing of Fig. 5 and test load of Fig. 6.	4.0 to 6.0	0.9			μs					
					4.0 to 6.0	2.0			Tcyc					
	"L"/"H". Level Pulse Width	tCKL			4.0 to 6.0	0.4			μs					
					4.0 to 6.0	tCKH	1.0			Tcyc				
	Rise/Fall Time	tCKR					4.0 to 6.0			0.1	μs			
tCKF														
Serial Input	Data Setup Time	tICK	SIO, SI1	Timing of Fig. 5, specified for SCK0, SCK1 rise (↑)	4.0 to 6.0	0.3			μs					
	Data Hold Time	tCKI			4.0 to 6.0	0.3			μs					
Serial Output	Output Delay Time	tCKO	S00, S01	Timing of Fig. 5 and test load of Fig. 6, specified for SCK0, SCK1 fall (↓)	4.0 to 6.0			0.3	μs					
Pulse Input Conditions	"H"/"L". Level Pulse Width at INT0	tIOH	INT0	Fig. 7. <ul style="list-style-type: none"> • Condition under which the INT0 interrupt is accepted • Condition under which the event counter/pulse width measure input by timer 0 is accepted 	4.0 to 6.0	2			Tcyc					
		tIOL												
	Interrupt Input "H"/"L". Level Pulse Width at Other than INT0	tIIH	INT1, INT2							<ul style="list-style-type: none"> • Condition under which each interrupt is accepted 	2			Tcyc
		tIIL	INT3, INT4 INT5											
"H"/"L". Level Pulse Width at PIN1	tPINH	PIN1	<ul style="list-style-type: none"> • Condition under which the event counter input by timer 1 is accepted 	2			Tcyc							
	tPINL													
"H"/"L". Level Pulse Width at RES	tRSH	RES	<ul style="list-style-type: none"> • Condition under which a reset is caused 	3			Tcyc							
	tRSL													
Comparator Response Time	TRS	PD	Fig. 8.		4.0 to 6.0			30	μs					
Current Dissipation at Operating Mode	IDD OP	VDD		4MHz ceramic resonator OSC	4.0 to 6.0		4.5	8	mA	8				
											4MHz external clock	6.5	11	mA
											RC OSC	4.0	8	mA

Continued on next page.

Continued from preceding page.

Parameter	Symbol	Applicable Pins	Conditions	VDD(V)	Limits			Unit	Note
					min	typ	max		
Current Dissipation at HALT Mode	IDDHALT	VDD	4MHz ceramic resonator OSC	4.0 to 6.0		1.0	2.5	mA	
			4MHz external clock			2	3.5		
			RC OSC			1.2	2.5		
Current Dissipation at HOLD Mode	IDDHOLD	VDD		1.8 to 6.0		0.01	10	μA	

- (Note 1) The input/output common ports are of open drain output type with output transistor OFF. When the CMOS output type is selected, the input/output common ports cannot be used as the input pins.
- (Note 2) The input/output common ports are of open drain output type with output transistor OFF. The specification for pull-up output type is specified by output pull-up current I_{PO}. When CMOS output type is selected, the input/output common ports cannot be used as the input pins.
- (Note 3) CMOS output type and output Nch transistor OFF (The open drain type can be also selected for P8.)
- (Note 4) Pull-up output type and output Nch transistor OFF.
- (Note 5) P8 is of CMOS output type.
- (Note 6) Open drain output type and output Nch transistor OFF.
- (Note 7) Open drain output type and output Pch transistor OFF.
- (Note 8) Reset mode.

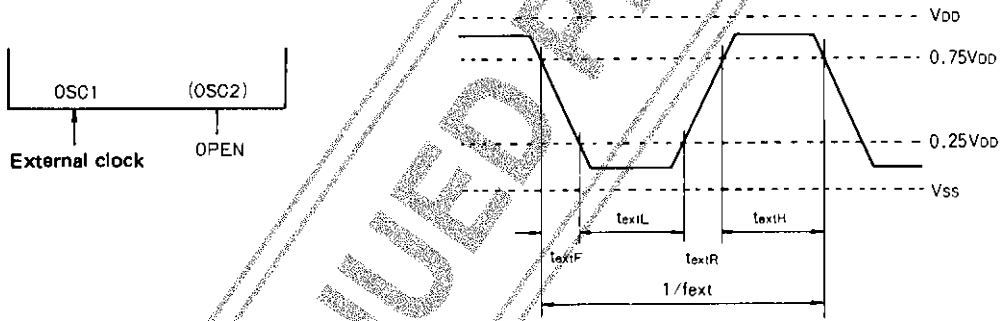

Fig. 1 External Clock Input Waveform

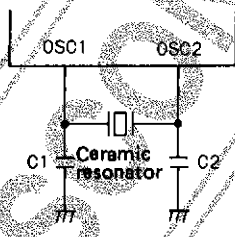

Fig. 2 Ceramic Resonator OSC Circuit

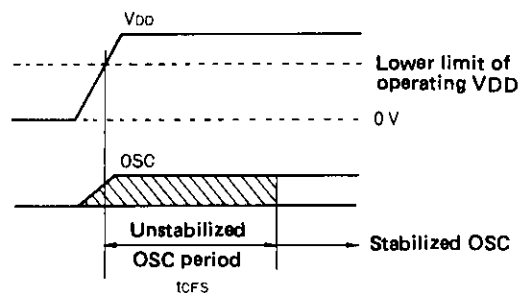

Fig. 3 OSC Stabilizing Period

External capacitor type	4 MHz (Murata) CSA4.00MG	C1	33pF ± 10%
		C2	33pF ± 10%
On-chip capacitor type	4 MHz (Murata) CST4.00MG		
	4 MHz (kyocera) KBR-4.0MES		

Table 1 Ceramic Resonator OSC-Guaranteed Constants

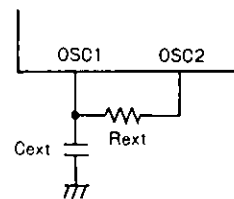

Fig. 4 RC OSC

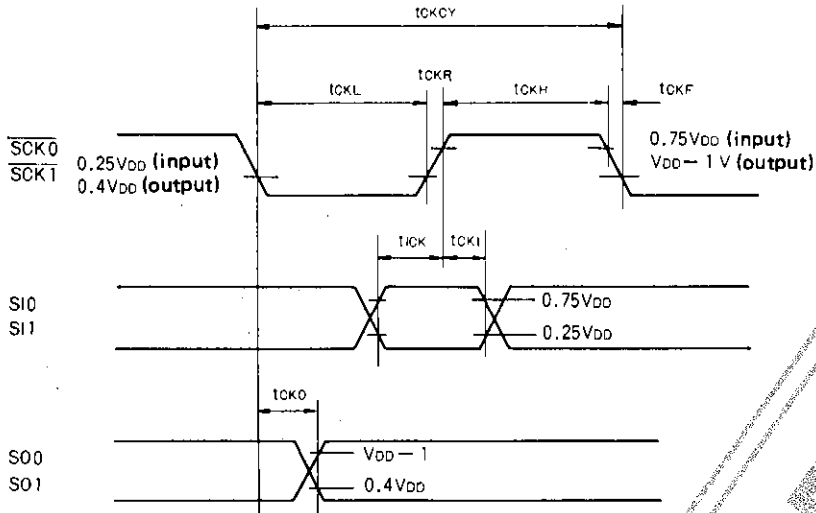

Fig. 5 Serial Input/Output Timing

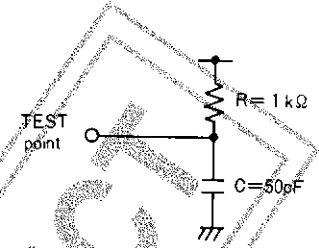

Fig. 6 Test Load

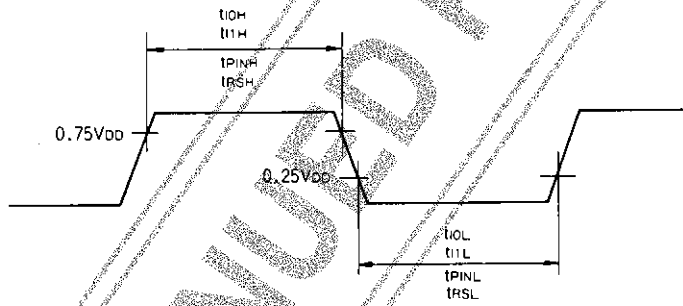

Fig. 7 INT0, INT1, INT2, INT3, INT4, INT5, PIN1, RES Input Timing

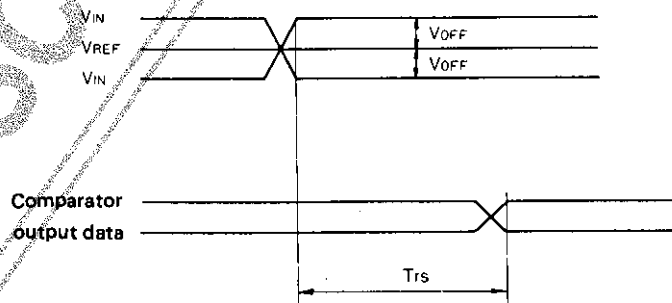

Fig. 8 Timing of Comparator Response Time Trs

RC OSC Characteristic of the LC66506B, 66508B

Fig. 9 shows the RC OSC characteristic of the LC66506B, 66508B. For the variation range of RC OSC frequency of the LC66506B, 66508B, the following are guaranteed at the external constants only shown below.

External constants $C_{ext}=100\text{pF}$, $R_{ext}=2.7\text{k}\Omega$
 $2.0\text{MHz} \leq f_{RC} \leq 4.0\text{MHz}$ ($T_a=-30^\circ\text{C}$ to $+70^\circ\text{C}$, $V_{DD}=4.0$ to 6.0V)

If any other constants than specified above are used, the range of $R_{ext}=2$ to $20\text{k}\Omega$, $C_{ext}=68$ to 150pF must be observed. (See Fig. 9.)

(Note 10) The OSC frequency at $V_{DD}=4.0$ to 6.0V , $T_a=-30$ to $+70^\circ\text{C}$ must be within the operation clock frequency range (0.4 to 4.3MHz).

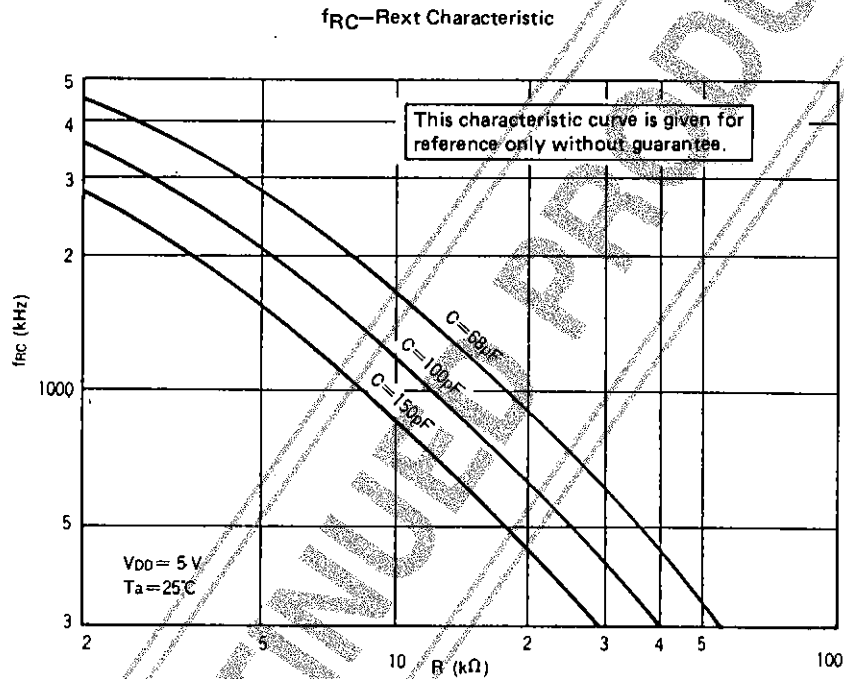
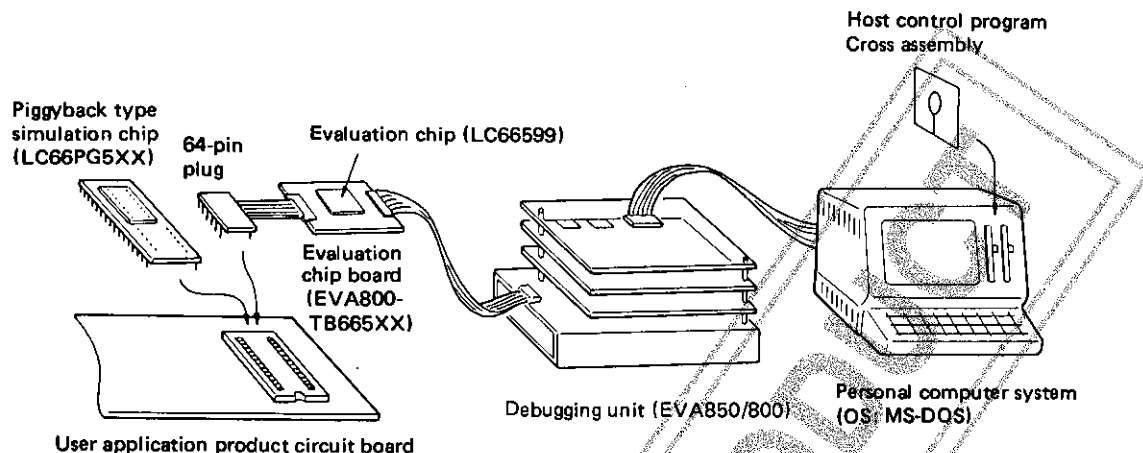

Fig. 9 RC OSC Frequency Data (Typ.)

- No products described or contained herein are intended for use in surgical implants, life-support systems, aerospace equipment, nuclear power control systems, vehicles, disaster/crime-prevention equipment and the like, the failure of which may directly or indirectly cause injury, death or property loss.
- Anyone purchasing any products described or contained herein for an above-mentioned use shall:
 - ① Accept full responsibility and indemnify and defend SANYO ELECTRIC CO., LTD., its affiliates, subsidiaries and distributors and all their officers and employees, jointly and severally, against any and all claims and litigation and all damages, cost and expenses associated with such use.
 - ② Not impose any responsibility for any fault or negligence which may be cited in any such claim or litigation on SANYO ELECTRIC CO., LTD., its affiliates, subsidiaries and distributors or any of their officers and employees jointly or severally.
- Information (including circuit diagrams and circuit parameters) herein is for example only; it is not guaranteed for volume production. SANYO believes information herein is accurate and reliable, but no guarantees are made or implied regarding its use or any infringements of intellectual property rights or other rights of third parties.

Application Development Tools

The programs for the LC66506A, 66508B microcomputers can be developed on the MS-DOS personal computer system (IBM-PC model system). Cross assembler for this system is provided. To help the user develop programs for the LC66506B, 66508B. microcomputers, the following development tools are prepared:



Appearance of Application Development Tools

(1) Program debugging unit (EVA850/800)

The program debugging unit (EVA800) is an emulator that includes the EPROM WRITE function and the parallel/serial data communications interface function between the unit itself and external systems (host computer, etc.). Application programs can be developed, corrected, and debugged at the machine language level. The debugging function can be carried out through break, step and trace operations. (Use the MPM665XX as the monitor ROM on the EVA800 debugging unit.)

(2) Evaluation chip board (EVA850/800-TB665XX)

The evaluation chip board sends control signals to the user application board through the 64-pin connector. Data is transferred between the I/O ports on the evaluation chip board and the user application board through the 64-pin connector. If the LC66599 evaluation chip is connected to the 64-pin plug by the output cable, the data from the LC66599 microcomputer is converted into the LC66506B, 66508B-bound data by the plug. There are jumper connectors on the evaluation chip board. They are used to select options and status levels. Therefore, using these jumper connectors, the same input/output formats and functions as those of the LC66506B, 66508B microcomputers can be selected on the evaluation chip board.

Jumpers

Type	OSC		Reset type selection		Power supply to the user application board through the evaluation chip board	
Jumper name	Jumper 1 (J1)		Jumper 2 (J2)		Jumper 3 (J3)	
Jumper setting and mode	EXT	External clock	INT	Reset by the RUN instruction from the host computer.	ON	VDD supply to the user application board through the evaluation chip board output.
	RC	RC OSC				
	CF	Ceramic resonator OSC	EXT	Reset by the reset circuit on the user application board	OFF	Power supply to the user application board from an independent power source (from the evaluation chip board)

Switch 1 (SW1)

Type	Output level selection for ports 0,1,8 at the reset						On-chip RAM capacity selection			Watchdog timer function selection	
	POS		P1S		P8S		RC0	RC1	Capacity	WDC	
Switch setting and mode	ON	Port 0 "H"	ON	Port 1 "H"	ON	Port 8 "H"	OPEN	OPEN	RESERVE	ON	Watchdog timer function selected
	OPEN	Port 0 "L"	OPEN	Port 0 "L"	OPEN	Port 8 "L"	OPEN	ON	512W	OPEN	Watchdog timer function not selected
							ON	ON	512W		

Switches SW2 to SW14: Pull-up resistor option select

- ① Set to ON when on-chip pull-up resistor is used. Set to OPEN when open drain output type is selected.
- ② Selectable for each pin.

LC66506B,66508B

(3) Cross assembler

Cross-assembler	Target device		
	Name	ROM (Kbit)	Functional differences
LC66S.EXE	LC66506B, LC66599	6	SB command invalid
	LC66508B, LC66599	8	SB command invalid

(4) Simulation chip

The simulation chip (LC66PG5XX) is a piggyback type microcomputer. An EPROM containing programs is mounted on this chip. Then, the simulation chip is incorporated into an application product board and actual operation can be monitored.

① External view and EPROM

The pin assignment and dimensions of the LC66PG5XX are the same as those of the LC66506B, 66508B. The pin assignment is shown below. The EPROMs to be mountable are 2764 and 27128.

② Reset output level of ports 0, 1, 8, watchdog timer function, and memory capacity selection

Select the reset output level of ports 0, 1, 8, watchdog timer function, and memory capacity according to a microcomputer to be evaluated. Set as shown below pins 1 to 6 of the 14-pin socket on the package surface.

Function type	Pin No.	Pin name	Pin setting	Function mode	
Port 0, port 1, and port 8 output level at reset	1	POHL	ON	Port output "H"	
	2	P1HL	OFF		
	3	P8HL			
Watchdog timer	6	WDC	ON	Operation	
			OFF	Halt	
On-chip RAM capacity	4	RAMC0	Pin setting		RAM capacity
			5	RAMC1	
			OFF	OFF	reserve
			OFF	ON	
			ON	OFF	
		ON	ON	512W	

ON: +5V voltage input OFF: Open

LC66PG5XX Pin Assignment

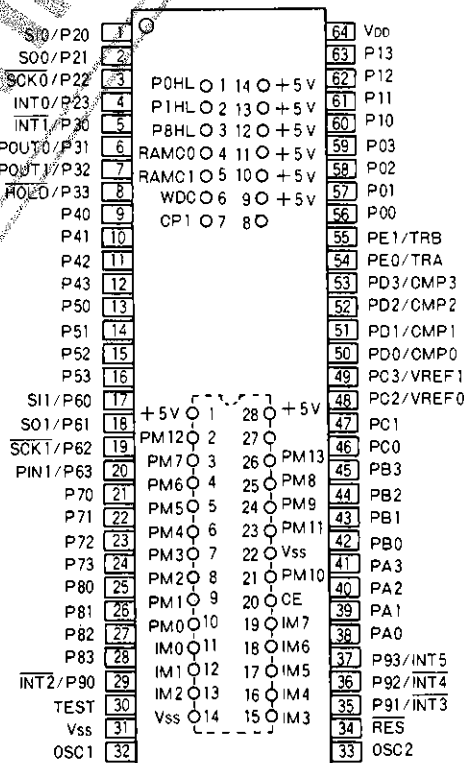

③ Power source for EPROM

Normal current dissipation per EPROM is in the range of 50mA to 100mA. When power capacity of an application product is not sufficient, power can be supplied to the EPROM from external independent power source. That is, the power source which is different from that on the application system can be selected. (See the figure given below.)

At the factory shipment, the +5V pin and V_{DD} pin are connected on the LC66PG5XX. Therefore, power is supplied to the EPROM from the LC66PG5XX power source terminal. Of the power source pads on the package surface, +5V pad is used to supply power to the EPROM.

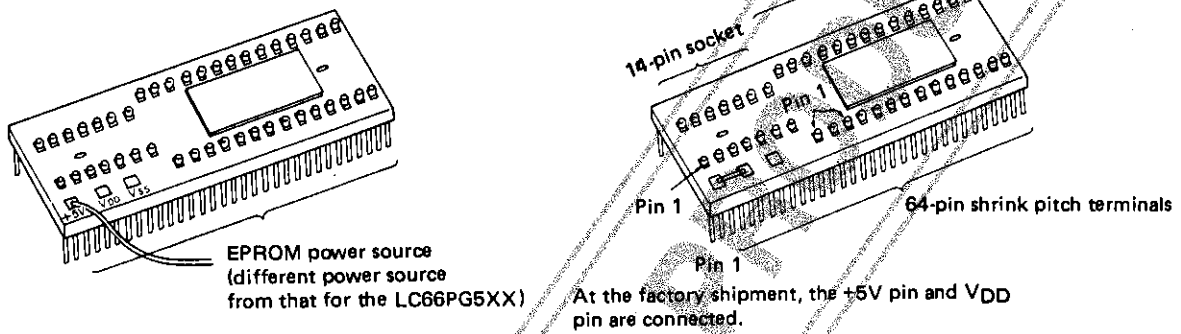

The LC66E516 microcontroller with built-in EPROM and LC66P516 microcontroller with built-in one-time programmable ROM are used as emulation chips for the LC66506B and LC66508B. Data sheets for the emulation chips are in preparation. Please contact your local representative for further information.

DISCONTINUED PRODUCT

LC665XX SERIES INSTRUCTION SET (BY FUNCTION)

- Symbol Description
- AC : Accumulator
 - E : E register
 - CF : Carry flag
 - ZF : Zero flag
 - HL : Data pointer DPH, DPL
 - XY : Data pointer DPX, DPY
 - M : Data memory
 - M (HL) : Data memory contents specified by data pointer DPH, DPL
 - M (XY) : Data memory contents specified by supplementary data pointer DPX, DPY
 - M2 (HL) : 2-word data memory contents specified by data pointer DPH, DPL
In this case, the accessed data memory area address must be multiples of 2 (even address).
 - SP : Stack pointer
 - M2 (SP) : 2-word data memory contents specified by stack pointer
 - M4 (SP) : 4-word data memory contents specified by stack pointer
 - in : n-bit immediate data
 - t2 : Bit specification

t2	11	10	01	00
Bit	2 ³	2 ²	2 ¹	2 ⁰

- PCh : Bits 8 to 11 of PC
- PCm : Bits 4 to 7 of PC
- PCl : Bits 0 to 3 of PC
- Fn : User's flag n=0 to 15
- TIMER0 : Timer 0
- TIMER1 : Timer 1
- SIO : Serial register
- P : Port
- P (i4) : Port contents specified by 4-bit immediate data
- INT : Interrupt enable flag
- (), [] : Contents
- ← : Transfer direction and operation result
- ⊖ : Exclusive logical sum
- ∧ : Logical product
- ∨ : Logical sum
- +
- : Subtraction
- : 1's complement

Instruction type	Mnemonics	Instruction code		Bytes	Cycles	Function	Description	Status flags affected	Remarks	
		D ₇ D ₆ D ₅ D ₄	D ₃ D ₂ D ₁ D ₀							
Accumulator manipulation instructions	CLA	Clear AC	1 0 0 0	0 0 0 0	1	1	AC ← 0 (Equivalent to LAI 0)	Clears AC.	ZF	Only the first instruction is effective; executed continuously (also function).
	DAA	Decimal adjust AC in addition	1 1 0 0 0 0 1 0	1 1 1 1 0 1 1 0	2	2	AC ← (AC) + 6 (Equivalent to ADI 6)	Adds 6 to AC.	ZF	
	DAS	Decimal adjust AC in subtraction	1 1 0 0 0 0 1 0	1 1 1 1 1 0 1 0	2	2	AC ← (AC) + 10 (Equivalent to ADI 0AH)	Adds 10 to AC.	ZF	
	CLC	Clear CF	0 0 0 1	1 1 1 0	1	1	CF ← 0	Clears CF.	CF	
	STC	Set CF	0 0 0 1	1 1 1 1	1	1	CF ← 1	Sets CF.	CF	
	CMA	Complement AC	0 0 0 1	1 0 0 0	1	1	AC ← $\overline{(AC)}$	Gives 1's complement of (invert) AC.	ZF	
	IA	Increment AC	0 0 0 1	0 1 0 0	1	1	AC ← (AC) + 1	Adds 1 to AC.	ZF, CF	
	DA	Decrement AC	0 0 1 0	0 1 0 0	1	1	AC ← (AC) - 1	Subtracts 1 from AC.	ZF, CF	
	RAR	Rotate AC right through CF	0 0 0 1	0 0 0 0	1	1	AC ₂ ← (CF), AC _n ← (AC _{n+1}), CF ← (AC ₀)	Rotates AC right through CF.	CF	
	RAL	Rotate AC left through CF	0 0 0 0	0 0 0 1	1	1	AC ₀ ← (CF), AC _n ← 1 ← (AC _n), CF ← (AC ₂)	Rotates AC left through CF.	CF, ZF	
Memory manipulation instructions	TAE	Transfer AC to E	0 1 0 0	0 1 0 1	1	1	E ← (AC)	Transfers the AC contents to the E register.		
	TEA	Transfer E to AC	0 1 0 0	0 1 1 0	1	1	AC ← (E)	Transfers the E register contents to AC.	ZF	
	XAE	Exchange AC with E	0 1 0 0	0 1 0 0	1	1	(AC) ↔ (E)	Exchanges the contents of the AC and E register.		
	IM	Increment M	0 0 0 1	0 0 1 0	1	1	M(HL) ← (M(HL)) + 1	Adds 1 to M(HL).	ZF, CF	
	DM	Decrement M	0 0 1 0	0 0 1 0	1	1	M(HL) ← (M(HL)) - 1	Subtracts 1 from M(HL).	ZF, CF	
	IMDR i8	Increment M direct	1 1 0 0 i ₇ i ₆ i ₅ i ₄	0 1 1 1 i ₃ i ₂ i ₁ i ₀	2	2	M(i8) ← (M(i8)) + 1	Adds 1 to M(i8).	ZF, CF	
	DMDR i8	Decrement M direct	1 1 0 0 i ₇ i ₆ i ₅ i ₄	0 0 1 1 i ₃ i ₂ i ₁ i ₀	2	2	M(i8) ← (M(i8)) - 1	Subtracts 1 from M(i8).	ZF, CF	
	SMB t2	Set M data bit	0 0 0 0	1 1 t ₁ t ₀	1	1	(M(HL), t2) ← 1	Sets a bit specified by t1t0 of M(HL).		
	RMB t2	Reset M data bit	0 0 1 0	1 1 t ₁ t ₀	1	1	(M(HL), t2) ← 0	Resets a bit specified by t1t0 of M(HL).	ZF	
	Operation/Comparison instructions	AD	Add M to AC	0 0 0 0	0 1 1 0	1	1	AC ← (AC) + (M(HL))	Adds together the contents of AC and M(HL) in binary and stores the result in AC.	ZF, CF
ADDR i8		Add M direct to AC	1 1 0 0 i ₇ i ₆ i ₅ i ₄	1 0 0 1 i ₃ i ₂ i ₁ i ₀	2	2	AC ← (AC) + (M(i8))	Adds together the contents of AC and M(i8) in binary and stores the result in AC.	ZF, CF	
ADC		Add M to AC with CF	0 0 0 0	0 0 1 0	1	1	AC ← (AC) + (M(HL)) + (CF)	Adds together the contents of AC, M(HL), and CF in binary and stores the result in AC.	ZF, CF	
ADI i4		Add immediate data to AC	1 1 0 0 0 0 1 0	1 1 1 1 i ₃ i ₂ i ₁ i ₀	2	2	AC ← (AC) + i ₃ i ₂ i ₁ i ₀	Adds together the contents of AC and immediate data in binary and stores the result in AC.	ZF	
SUBC		Subtract AC from M with CF	0 0 0 1	0 1 1 1	1	1	AC ← (M(HL)) - (AC) - (CF)	Subtracts the contents of AC from M(HL) with CF in binary and stores the result in AC.	ZF, CF	CF=0 if there is a borrow while CF=1 if there is no borrow.
ANDA		AND M with AC then store AC	0 0 0 0	0 1 1 1	1	1	AC ← (AC) ∧ (M(HL))	Performs a logical AND operation between AC and M(HL) and stores the result in AC.	ZF	
ORA		OR M with AC then store AC	0 0 0 0	0 1 0 1	1	1	AC ← (AC) ∨ (M(HL))	Performs a logical OR operation between AC and M(HL) and stores the result in AC.	ZF	
EXL		Exclusive OR M with AC then store AC	0 0 0 1	0 1 0 1	1	1	AC ← (AC) ⊕ (M(HL))	Performs a logical exclusive OR operation between AC and M(HL) and stores the result in AC.	ZF	
ANDM		AND M with AC then store M	0 0 0 0	0 0 1 1	1	1	M(HL) ← (AC) ∧ (M(HL))	Performs a logical AND operation between AC and M(HL) and stores the result in M(HL).	ZF	
ORM		OR M with AC then store M	0 0 0 0	0 1 0 0	1	1	M(HL) ← (AC) ∨ (M(HL))	Performs a logical OR operation between AC and M(HL) and stores the results in M(HL).	ZF	

Instruction type	Mnemonics	Instruction code		Bytes	Cycles	Function	Description	Status flags affected	Remarks												
		D ₇ D ₆ D ₅ D ₄	D ₃ D ₂ D ₁ D ₀																		
Operation/Comparison instructions	CM	Compare AC with M	0 0 0 1	0 1 1 0	1	1	$\{M(HL)\} + (AC) + 1$ Compares the contents of AC and M(HL) and then sets/resets the carry flag (CF) and zero flag (ZF).	ZF, CF													
							<table border="1"> <tr> <th>Comparison relations</th> <th>CF</th> <th>ZF</th> </tr> <tr> <td>$\{M(HL)\} > (AC)$</td> <td>0</td> <td>0</td> </tr> <tr> <td>$\{M(HL)\} = (AC)$</td> <td>1</td> <td>1</td> </tr> <tr> <td>$\{M(HL)\} < (AC)$</td> <td>1</td> <td>0</td> </tr> </table>	Comparison relations	CF	ZF	$\{M(HL)\} > (AC)$	0	0	$\{M(HL)\} = (AC)$	1	1	$\{M(HL)\} < (AC)$	1	0		
	Comparison relations	CF	ZF																		
	$\{M(HL)\} > (AC)$	0	0																		
$\{M(HL)\} = (AC)$	1	1																			
$\{M(HL)\} < (AC)$	1	0																			
CI i4	Compare AC with immediate data	1 1 0 0 1 0 1 0	1 1 1 1 i ₃ i ₂ i ₁ i ₀	2	2	$i_3 i_2 i_1 i_0 + (AC) + 1$ Compares the contents of the accumulator (AC) and immediate data (i ₃ i ₂ i ₁ i ₀) and sets/resets the zero flag (ZF) and carry flag (CF).	ZF, CF														
						<table border="1"> <tr> <th>Comparison relations</th> <th>CF</th> <th>ZF</th> </tr> <tr> <td>$i_3 i_2 i_1 i_0 > AC$</td> <td>0</td> <td>0</td> </tr> <tr> <td>$i_3 i_2 i_1 i_0 = AC$</td> <td>1</td> <td>1</td> </tr> <tr> <td>$i_3 i_2 i_1 i_0 < AC$</td> <td>1</td> <td>0</td> </tr> </table>	Comparison relations	CF	ZF	$i_3 i_2 i_1 i_0 > AC$	0	0	$i_3 i_2 i_1 i_0 = AC$	1	1	$i_3 i_2 i_1 i_0 < AC$	1	0			
Comparison relations	CF	ZF																			
$i_3 i_2 i_1 i_0 > AC$	0	0																			
$i_3 i_2 i_1 i_0 = AC$	1	1																			
$i_3 i_2 i_1 i_0 < AC$	1	0																			
CLI i4	Compare DPL with immediate data	1 1 0 0 1 0 1 1	1 1 1 1 i ₃ i ₂ i ₁ i ₀	2	2	ZF-1 if (DPL) = i ₃ i ₂ i ₁ i ₀ ZF-0 if (DPL) ≠ i ₃ i ₂ i ₁ i ₀ Compares the contents of DPL and immediate data and sets the zero flag (ZF) if they are equal, or resets the flag if not equal.	ZF														
CMB t2	Compare AC bit with M data bit	1 1 0 0 1 1 0 1	1 1 1 1 0 0 t ₁ t ₀	2	2	ZF-1 if (AC, t ₂) = (M(HL), t ₂) ZF-0 if (AC, t ₂) ≠ (M(HL), t ₂) Compares the contents of AC and M(HL) bit specified by the 2 bits (t ₁ and t ₂) of the instruction and sets the zero flag (ZF) if they are equal, or resets the flag if not equal.	ZF														
Load/store instructions	LAE	Load AC and E from M2 (HL)	0 1 0 1	1 1 0 0	1	1	AC ← M(HL) E ← M(HL + 1) Loads the contents of M2(HL) into the AC and the E register.														
	LAI i4	Load AC with immediate data	1 0 0 0	i ₃ i ₂ i ₁ i ₀	1	1	AC ← i ₃ i ₂ i ₁ i ₀ Loads immediate data into AC.	ZF	Only the first instruction is effective if executed continuously (loop function).												
	LADR i8	Load AC from M direct	1 1 0 0 i ₇ i ₆ i ₅ i ₄	0 0 0 1 i ₃ i ₂ i ₁ i ₀	2	2	AC ← (M(i8)) Loads the contents of M(i8) into AC.	ZF													
	S	Store AC to M	0 1 0 0	0 1 1 1	1	1	M(HL) ← (AC) Stores the contents of AC into M(HL).														
	SAE	Store AC and E to M2 (HL)	0 1 0 1	1 1 1 0	1	1	M(HL) ← (AC) M(HL + 1) ← (E) Stores the contents of AC and the E register into M2(HL).														
	LA reg	Load AC from M(reg)	0 1 0 0	1 0 t ₀ 0	1	1	AC ← (M(reg)) Loads the contents of M(reg) into AC. reg is either an HL or XY.	ZF													
							<table border="1"> <tr> <th>reg</th> <th>to</th> </tr> <tr> <td>HL</td> <td>0</td> </tr> <tr> <td>XY</td> <td>1</td> </tr> </table>	reg	to	HL	0	XY	1								
	reg	to																			
	HL	0																			
	XY	1																			
LA reg, i	Load AC from M(reg) then increment reg	0 1 0 0	1 0 t ₀ 1	1	2	AC ← (M(reg)) DPL ← (DPL) + 1 or DPY ← (DPY) + 1 Loads the contents of M(reg) into the accumulator (AC). reg is either an HL or XY. After loading, increments the contents of DPL or DPY. Refer to the LA reg instruction for the relationship between reg and t ₀ .	ZF	ZF status depends on DPL or DPY increment result.													
LA reg, D	Load AC from M(reg) then decrement reg	0 1 0 1	1 0 t ₀ 1	1	2	AC ← (M(reg)) DPL ← (DPL) - 1 or DPY ← (DPY) - 1 Loads the contents of M(reg) into AC. reg is either an HL or XY. After loading, decrements the contents of DPL or DPY. Refer to the LA reg instruction for the relationship between reg and t ₀ .	ZF	ZF status depends on DPL or DPY decrement result.													
XA reg	Exchange AC with M(reg)	0 1 0 0	1 1 t ₀ 0	1	1	(AC) ← (M(reg)) Exchanges the contents of AC and M(reg). reg is either an HL or XY.															
						<table border="1"> <tr> <th>reg</th> <th>to</th> </tr> <tr> <td>HL</td> <td>0</td> </tr> <tr> <td>XY</td> <td>1</td> </tr> </table>	reg	to	HL	0	XY	1									
reg	to																				
HL	0																				
XY	1																				
XA reg, i	Exchange AC with M(reg) then increment reg	0 1 0 0	1 1 t ₀ 1	1	2	(AC) ← (M(reg)) DPL ← (DPL) + 1 or DPY ← (DPY) + 1 Exchanges the contents of AC and M(reg). reg is either an HL or XY. After exchanging, increments the contents of DPL or DPY. Refer to the XA reg instruction for the relationship between reg and t ₀ .	ZF	ZF status depends on DPL or DPY increment result.													
XA reg, D	Exchange AC with M(reg) then decrement reg	0 1 0 1	1 1 t ₀ 1	1	2	(AC) ← (M(reg)) DPL ← (DPL) - 1 or DPY ← (DPY) - 1 Exchanges the contents of AC and M(reg). reg is either an HL or XY. After exchanging, decrements the contents of DPL or DPY. Refer to the XA reg instruction for the relationship between reg and t ₀ .	ZF	ZF status depends on DPL or DPY decrement result.													
XADR i8	Exchange AC with M direct	1 1 0 0 i ₇ i ₆ i ₅ i ₄	1 0 0 0 i ₃ i ₂ i ₁ i ₀	2	2	(AC) ← (M(i8)) Exchanges the contents of AC and M(i8).															

Instruction type	Mnemonics	Instruction code		Bytes	Cycles	Function	Description	Status flags affected	Remarks
		D ₇ D ₆ D ₅ D ₄	D ₃ D ₂ D ₁ D ₀						
Load/store instructions	LEAI i8 Load E & AC with immediate data	1 1 0 0 i ₇ i ₆ i ₅ i ₄	0 1 1 0 i ₃ i ₂ i ₁ i ₀	2	2	E ← i ₇ i ₆ i ₅ i ₄ AC ← i ₃ i ₂ i ₁ i ₀	Loads immediate data i8 into the E register and the accumulator (AC).		
	RTBL Read table data from program ROM	0 1 0 1	1 0 1 0	1	2	E, AC ← (ROM(PCh, E, AC))	First, replace the contents of lower 8 bits of PC with the E register and AC contents. Then, loads the ROM data at an address specified by the new contents of the lower 8 bits of PC into the E register and AC.		
	RTBLP Read table data from program ROM then output to P4,5	0 1 0 1	1 0 0 0	1	2	Port 4, 5 ← (ROM(PCh, E, AC))	First, replaces the contents of lower 8 bits of AC with the E register and AC contents. Then, outputs the ROM data at an address specified by the new contents of the lower 8 bits of PC to ports 4 and 5.		
Data pointer manipulation instructions	LDZ i4 Load DP _H with zero and DP _L with immediate data respectively	0 1 1 0	i ₃ i ₂ i ₁ i ₀	1	1	DP _H ← 0 DP _L ← i ₃ i ₂ i ₁ i ₀	Loads the data of 0 (zero) and immediate data i4 into the DP _H and DP _L respectively.		
	LHI i4 Load DP _H with immediate data	1 1 0 0 0 0 0 0	i ₃ i ₂ i ₁ i ₀	2	2	DP _H ← i ₃ i ₂ i ₁ i ₀	Loads immediate data i4 into the DP _H .		
	LLI i4 Load DP _L with immediate data	1 1 0 0 0 0 0 1	i ₃ i ₂ i ₁ i ₀	2	2	DP _L ← i ₃ i ₂ i ₁ i ₀	Loads immediate data i4 into the DP _L .		
	LHLI i8 Load DP _H , DP _L with immediate data	1 1 0 0 i ₇ i ₆ i ₅ i ₄	0 0 0 0 i ₃ i ₂ i ₁ i ₀	2	2	DP _H ← i ₇ i ₆ i ₅ i ₄ DP _L ← i ₃ i ₂ i ₁ i ₀	Loads immediate data into the DP _H and DP _L .		
	LXYI i8 Load DP _X , DP _Y with immediate data	1 1 0 0 i ₇ i ₆ i ₅ i ₄	0 0 1 0 i ₃ i ₂ i ₁ i ₀	2	2	DP _X ← i ₇ i ₆ i ₅ i ₄ DP _Y ← i ₃ i ₂ i ₁ i ₀	Loads immediate data into the DP _X and DP _Y .		
	IL Increment DP _L	0 0 0 1	0 0 0 1	1	1	DP _L ← (DP _L) + 1	Increments the contents of the DP _L by 1.	ZF	
	DL Decrement DP _L	0 0 1 0	0 0 0 1	1	1	DP _L ← (DP _L) - 1	Decrements the contents of the DP _L by 1.	ZF	
	IY Increment DP _Y	0 0 0 1	0 0 1 1	1	1	DP _Y ← (DP _Y) + 1	Increments the contents of the DP _Y by 1.	ZF	
	DY Decrement DP _Y	0 0 1 0	0 0 1 1	1	1	DP _Y ← (DP _Y) - 1	Decrements the contents of the DP _Y by 1.	ZF	
	TAH Transfer AC to DP _H	1 1 0 0 1 1 1 1	1 1 1 1 0 0 0 0	2	2	DP _H ← (AC)	Transfers the contents of the accumulator (AC) to the DP _H .		
	THA Transfer DP _H to AC	1 1 0 0 1 1 1 0	1 1 1 1 0 0 0 0	2	2	AC ← (DP _H)	Transfers the contents of the DP _H to the AC.	ZF	
	XAH Exchange AC with DP _H	0 1 0 0	0 0 0 0	1	1	(AC) ↔ (DP _H)	Exchanges the contents of the accumulator (AC) and the DP _H .		
	TAL Transfer AC to DP _L	1 1 0 0 1 1 1 1	1 1 1 1 0 0 0 1	2	2	DP _L ← (AC)	Transfers the contents of the accumulator (AC) to the DP _L .		
	TLA Transfer DP _L to AC	1 1 0 0 1 1 1 0	1 1 1 1 0 0 0 1	2	2	AC ← (DP _L)	Transfers the contents of the DP _L to the accumulator (AC).	ZF	
	XAL Exchange AC with DP _L	0 1 0 0	0 0 0 1	1	1	(AC) ↔ (DP _L)	Exchanges the contents of the AC and DP _L .		
	TAX Transfer AC to DP _X	1 1 0 0 1 1 1 1	1 1 1 1 0 0 1 0	2	2	DP _X ← (AC)	Transfers the contents of the accumulator (AC) to the DP _X .		
	TXA Transfer DP _X to AC	1 1 0 0 1 1 1 0	1 1 1 1 0 0 1 0	2	2	AC ← (DP _X)	Transfers the contents of DP _X to the AC.	ZF	
	XAX Exchange AC with DP _X	0 1 0 0	0 0 1 0	1	1	(AC) ↔ (DP _X)	Exchanges the contents of the AC and DP _X .		
	TAY Transfer AC to DP _Y	1 1 0 0 1 1 1 1	1 1 1 1 0 0 1 1	2	2	DP _Y ← (AC)	Transfers the contents of the accumulator (AC) to the DP _Y .		
	TYA Transfer DP _Y to AC	1 1 0 0 1 1 1 0	1 1 1 1 0 0 1 1	2	2	AC ← (DP _Y)	Transfers the contents of the DP _Y to the AC.	ZF	
XAY Exchange AC with DP _Y	0 1 0 0	0 0 1 1	1	1	(AC) ↔ (DP _Y)	Exchanges the contents of the accumulator (AC) and the DP _Y .			
Flag manipulation instructions	SFB n4 Set flag bit	0 1 1 1	n ₃ n ₂ n ₁ n ₀	1	1	F _n ← 1	Sets a flag specified by n4.		
	RFB n4 Reset flag bit	0 0 1 1	n ₃ n ₂ n ₁ n ₀	1	1	F _n ← 0	Resets a flag specified by n4.	ZF	
Jump/subroutine instructions	JMP addr Jump in the current bank	1 1 1 0 P ₇ P ₆ P ₅ P ₄	P ₁₁ P ₁₀ P ₉ P ₈ P ₃ P ₂ P ₁ P ₀	2	2	PC ₁₂ ← PC ₁₂ PC ₁₁ ← 0 - P ₁₁ - P ₀	Jumps to an address specified by immediate data P ₁₁ - P ₀ in the current bank.		When executed immediately after the BANK instruction, PC ₁₂ ← (PC ₁₂).
	JPEA Jump to the address stored at E and AC in the current page	0 0 1 0	0 1 1 1	1	1	PC ₁₂ ← PC ₈ - PC ₁₂ - PC ₈ PC ₇ ← 4 - (E) PC ₃ ← 0 - (AC)	Jumps to an address specified by the contents of the E register and accumulator (AC) which have replaced the contents of lower 8 bits of the program counter (PC).		

Instruction type	Mnemonics	Instruction code		Bytes	Cycles	Function	Description	Status flags affected	Remarks															
		D ₇ D ₆ D ₅ D ₄	D ₃ D ₂ D ₁ D ₀																					
Jump/subroutine instructions	CAL addr	Call subroutine	0 1 0 1 P ₇ P ₆ P ₅ P ₄	0 P ₁₀ P ₉ P ₈ P ₃ P ₂ P ₁ P ₀	2	2	PC12, 11←0 PC10←0—P ₁₀ ~P ₀ M4(SP)←(CF, ZF PC12←0) SP←(SP)-4	Calls a subroutine.																
	CZP addr	Call subroutine in the zero page	1 0 1 0	P ₃ P ₂ P ₁ P ₀	1	2	PC12←6, PC1←0←0 PC5←2←P ₃ ~P ₀ M4(SP)←(CF, ZF, PC12←0) SP←SP-4	Calls a subroutine in page 0 of bank 0.																
	BANK	Change bank	0 0 0 1	1 0 1 1	1	1		Changes memory banks and register banks.																
	PUSH reg	Push reg on M2(SP)	1 1 0 0 1 1 1 1	1 1 1 1 1 i ₁ i ₀ 0	2	2	M2(SP)←(reg) SP←(SP)-2	Stores the contents of reg into the M2(SP) and then subtracts 2 from the stack pointer (SP). <table border="1" style="margin-left: 20px;"> <tr> <td>reg</td> <td>i₁</td> <td>i₀</td> </tr> <tr> <td>HL</td> <td>0</td> <td>0</td> </tr> <tr> <td>XY</td> <td>0</td> <td>1</td> </tr> <tr> <td>AE</td> <td>1</td> <td>0</td> </tr> <tr> <td>Inhibited</td> <td>1</td> <td>1</td> </tr> </table>	reg	i ₁	i ₀	HL	0	0	XY	0	1	AE	1	0	Inhibited	1	1	
	reg	i ₁	i ₀																					
	HL	0	0																					
	XY	0	1																					
AE	1	0																						
Inhibited	1	1																						
POP reg	Pop reg off M2(SP)	1 1 0 0 1 1 1 0	1 1 1 1 1 i ₁ i ₀ 0	2	2	SP←(SP)+2 reg←(M2(SP))	Stores the contents of reg into the M2(SP) and then increments the contents of the stack pointer (SP) by 2 and loads the contents of M2(SP) into reg. Refer to the PUSH reg instruction for the relationship between i ₁ i ₀ and reg.																	
RT	Return from subroutine	0 0 0 1	1 1 0 0	1	2	SP←(SP)+4 PC←(M4(SP))	Returns execution from a subroutine or interrupt processing routine back to the routine that called it. The contents of the carry flag (CF) and zero flag (ZF) are not returned from the stack area.																	
RTI	Return from interrupt routine	0 0 0 1	1 1 0 1	1	2	SP←(SP)+4 PC←(M4(SP)) CF, ZF←(M4(SP))	Returns execution from a subroutine or interrupt processing routine back to the routine that called it. The contents of the carry flag (CF) and zero flag (ZF) are returned from the stack area.	ZF, CF																
Branch instructions	BAt2 addr	Branch on AC bit	1 1 0 1 P ₇ P ₆ P ₅ P ₄	0 0 t ₁ t ₀ P ₃ P ₂ P ₁ P ₀	2	2	PC7←0—P ₇ P ₆ P ₅ P ₄ P ₃ P ₂ P ₁ P ₀ if(AC, t2)=1	Transfers execution to an address specified by the contents of P7 to P0 in the current page if a bit specified by immediate data t1t0 of AC is 1 (program branch).																
	BNA12 addr	Branch on no AC bit	1 0 0 1 P ₇ P ₆ P ₅ P ₄	0 0 t ₁ t ₀ P ₃ P ₂ P ₁ P ₀	2	2	PC7←0—P ₇ P ₆ P ₅ P ₄ P ₃ P ₂ P ₁ P ₀ if(AC, t2)=0	Transfers execution to an address specified by the contents of P7 to P0 in the current page if a bit specified by immediate data t1t0 of AC is 0 (program branch).																
	BMt2 addr	Branch on M bit	1 1 0 1 P ₇ P ₆ P ₅ P ₄	0 1 t ₁ t ₀ P ₃ P ₂ P ₁ P ₀	2	2	PC7←0—P ₇ P ₆ P ₅ P ₄ P ₃ P ₂ P ₁ P ₀ if(M(HL), t2)=1	Transfers execution to an address specified by the contents of P7 to P0 in the current page if a bit specified by immediate data t1t0 of M(HL) is 1 (program branch).																
	BNMt2 addr	Branch on no M bit	1 0 0 1 P ₇ P ₆ P ₅ P ₄	0 1 t ₁ t ₀ P ₃ P ₂ P ₁ P ₀	2	2	PC7←0—P ₇ P ₆ P ₅ P ₄ P ₃ P ₂ P ₁ P ₀ if(M(HL), t2)=0	Transfers execution to an address specified by the contents of P7 to P0 in the current page if a bit specified by immediate data t1t0 of M(HL) is 0 (program branch).																
	BPt2 addr	Branch on Port bit	1 1 0 1 P ₇ P ₆ P ₅ P ₄	1 0 t ₁ t ₀ P ₃ P ₂ P ₁ P ₀	2	2	PC7←0—P ₇ P ₆ P ₅ P ₄ P ₃ P ₂ P ₁ P ₀ if(P(DPL), t2)=1	Transfers execution to an address specified by the contents of P7 to P0 in the current page if a bit specified by immediate data t1t0 of the port accessed by DPL is 1 (program branch).	Used to manipulate internal control registers if executed immediately after the BANK instruction. In this case, the internal control registers must be readable.															
	BNPt2 addr	Branch on no Port bit	1 0 0 1 P ₇ P ₆ P ₅ P ₄	1 0 t ₁ t ₀ P ₃ P ₂ P ₁ P ₀	2	2	PC7←0—P ₇ P ₆ P ₅ P ₄ P ₃ P ₂ P ₁ P ₀ if(P(DPL), t2)=0	Transfers execution to an address specified by the contents of P7 to P0 in the current page if a bit specified by immediate data t1t0 of the port accessed by DPL is 0 (program branch).	Same as above.															
	BC addr	Branch on CF	1 1 0 1 P ₇ P ₆ P ₅ P ₄	1 1 0 0 P ₃ P ₂ P ₁ P ₀	2	2	PC7←0—P ₇ P ₆ P ₅ P ₄ P ₃ P ₂ P ₁ P ₀ if(CF)=1	Transfers execution to an address specified by the contents of P7 to P0 in the current page if the content of the carry flag (CF) is 1 (program branch).																
	BNC addr	Branch on no CF	1 0 0 1 P ₇ P ₆ P ₅ P ₄	1 1 0 0 P ₃ P ₂ P ₁ P ₀	2	2	PC7←0—P ₇ P ₆ P ₅ P ₄ P ₃ P ₂ P ₁ P ₀ if(CF)=0	Transfers execution to an address specified by the contents of P7 to P0 in the current page if the content of the carry flag (CF) is 0 (program branch).																
	BZ addr	Branch on ZF	1 1 0 1 P ₇ P ₆ P ₅ P ₄	1 1 0 1 P ₃ P ₂ P ₁ P ₀	2	2	PC7←0—P ₇ P ₆ P ₅ P ₄ P ₃ P ₂ P ₁ P ₀ if(ZF)=1	Transfers execution to an address specified by the contents of P7 to P0 in the current page if the content of the zero flag (ZF) is 1 (program branch).																
	BNZ addr	Branch on no ZF	1 0 0 1 P ₇ P ₆ P ₅ P ₄	1 1 0 1 P ₃ P ₂ P ₁ P ₀	2	2	PC7←0—P ₇ P ₆ P ₅ P ₄ P ₃ P ₂ P ₁ P ₀ if(ZF)=0	Transfers execution to an address specified by the contents of P7 to P0 in the current page if the content of the zero flag (ZF) is 0 (program branch).																

Instruction type	Mnemonics	Instruction code		Bytes	Cycles	Function	Description	Status flags affected	Remarks	
		D ₇ D ₆ D ₅ D ₄	D ₃ D ₂ D ₁ D ₀							
Branch instructions	BFn4 addr	Branch on flag bit	1 1 1 1 P ₇ P ₆ P ₅ P ₄	n ₃ n ₂ n ₁ n ₀ P ₃ P ₂ P ₁ P ₀	2	2	PC7-0 ← P ₇ P ₆ P ₅ P ₄ P ₃ P ₂ P ₁ P ₀ if(Fn) = 1	Transfers execution to an address specified by the contents of P7 to P0 in the current page if the content of the flag specified by n3n2n1n0 is 1. The flag is one of the 16 flags.		
	BNFn4 addr	Branch on no flag bit	1 0 1 1 P ₇ P ₆ P ₅ P ₄	n ₃ n ₂ n ₁ n ₀ P ₃ P ₂ P ₁ P ₀	2	2	PC7-0 ← P ₇ P ₆ P ₅ P ₄ P ₃ P ₂ P ₁ P ₀ if(Fn) = 0	Transfers execution to an address specified by the contents of P7 to P0 in the current page if the content of the flag specified by n3n2n1n0 is 0. The flag is one of the 16 flags.		
Input/output instructions	IPO	Input port 0 to AC	0 0 1 0	0 0 0 0	1	1	AC ← (P0)	Inputs the contents of port 0 to the accumulator (AC).	ZF	
	IP	Input port to AC	0 0 1 0	0 1 1 0	1	1	AC ← (P(DPL))	Inputs the contents of port accessed by DPL to the accumulator (AC).	ZF	
	IPM	Input port to M	0 0 0 1	1 0 0 1	1	1	M(HL) ← (P(DPL))	Inputs the contents of port accessed by DPL to the M(HL).		
	IPDR i4	Input port to AC direct	1 1 0 0 0 1 1 0	1 1 1 1 i ₃ i ₂ i ₁ i ₀	2	2	AC ← (P(i4))	Inputs the contents of port accessed by i4 to the accumulator (AC).	ZF	
	IP45	Input port 4,5 to E, AC respectively	1 1 0 0 1 1 0 1	1 1 1 1 0 1 0 0	2	2	E ← (P(4)) AC ← (P(5))	Inputs the contents of ports 4 and 5 to the E register and accumulator (AC) respectively.		
	OP	Output AC to port	0 0 1 0	0 1 0 1	1	1	P(DPL) ← (AC)	Outputs the contents of the accumulator (AC) to a port accessed by DPL.		
	OPM	Output M to port	0 0 0 1	1 0 1 0	1	1	P(DPL) ← (M(HL))	Outputs the contents of the M(HL) to a port accessed by DPL.		
	OPDR i4	Output AC to port direct	1 1 0 0 0 1 1 1	1 1 1 1 i ₃ i ₂ i ₁ i ₀	2	2	P(i4) ← (AC)	Outputs the contents of the accumulator (AC) to a port accessed by i4.		
	OP45	Output E, AC to port 4,5 respectively	1 1 0 0 1 1 0 1	1 1 1 1 0 1 0 1	2	2	P(4) ← (E) P(5) ← (AC)	Outputs the contents of the E register and accumulator (AC) to ports 4 and 5 respectively.		
	SPB i2	Set port bit	0 0 0 0	1 0 t ₁ t ₀	1	1	(P(DPL), t2) ← 1	Sets a bit specified by immediate data t1t0 of a port accessed by DPL.		
	RPB i2	Reset port bit	0 0 1 0	1 0 t ₁ t ₀	1	1	(P(DPL), t2) ← 0	Resets a bit specified by immediate data t1t0 of a port accessed by DPL.	ZF	
	ANOPDR i4, p4	AND port with immediate data then output	1 1 0 0 i ₃ i ₂ i ₁ i ₀	0 1 0 1 P ₃ P ₂ P ₁ P ₀	2	2	P(P ₃ ~P ₀) ← (P(P ₃ ~P ₀) ∨ i ₃ ~i ₀)	Performs a logical AND operation between the contents of a port specified by P3 to P0 and immediate data i3i2i1i0 and outputs the resulted product to the port.	ZF	
	ORPDR i4, p4	OR port with immediate data then output	1 1 0 0 i ₃ i ₂ i ₁ i ₀	0 1 0 0 P ₃ P ₂ P ₁ P ₀	2	2	P(P ₃ ~P ₀) ← (P(P ₃ ~P ₀) ∨ i ₃ ~i ₀)	Performs a logical OR operation between the contents of a port specified by P3 to P0 and immediate data i3i2i1i0 and outputs the resulted sum to the port.	ZF	
Timer control instructions	WTTM0	Write timer 0	1 1 0 0	1 0 1 0	1	2	TIMER0 ← (M2(HL)), (AC)	Writes the contents of the M(HL) and the accumulator (AC) to the timer 0 reload register.		
	WTTM1	Write timer 1	1 1 0 0 1 1 1 1	1 1 1 1 0 1 0 0	2	2	TIMER1 ← (E), (AC)	Writes the contents of the E register and the accumulator (AC) to the timer 1 reload register.		
	RTIM0	Read timer 0	1 1 0 0	1 0 1 1	1	2	M2(HL), AC ← (TIMER0)	Reads the contents of the timer 0 counter into the M2(HL) and the accumulator (AC).		
	RTIM1	Read timer 1	1 1 0 0 1 1 1 1	1 1 1 1 0 1 0 1	2	2	E, AC ← (TIMER1)	Reads the contents of the timer 1 counter into the E register and the accumulator (AC).		
	START0	Start timer 0	1 1 0 0 1 1 1 0	1 1 1 1 0 1 1 0	2	2	Start timer 0 counter	Starts the timer 0 counter operation.		
	START1	Start timer 1	1 1 0 0 1 1 1 0	1 1 1 1 0 1 1 1	2	2	Start timer1 counter	Starts the timer 1 counter operation.		
	STOP0	Stop timer 0	1 1 0 0 1 1 1 1	1 1 1 1 0 1 1 0	2	2	Stop timer 0 counter	Stops the timer 0 counter operation.		
	STOP1	Stop timer 1	1 1 0 0 1 1 1 1	1 1 1 1 0 1 1 1	2	2	Stop timer1 counter	Stops the timer 1 counter operation.		

Instruction type	Mnemonics	Instruction code		Bytes	Cycles	Function	Description	Status flags affected	Remarks
		D ₇ D ₆ D ₅ D ₄	D ₃ D ₂ D ₁ D ₀						
Interrupt control instructions	MSET	Set Interrupt Master Enable Flag	1 1 0 0 0 1 0 1	1 1 0 1 0 0 0 0	2	2	MSE←1	Sets the Interrupt master enable flag.	
	MRESET	Reset Interrupt Master Enable Flag	1 1 0 0 1 0 0 1	1 1 0 1 0 0 0 0	2	2	MSE←0	Resets the interrupt master enable flag.	
	EIH i4	Enable interrupt high	1 1 0 0 0 1 0 1	1 1 0 1 i ₃ i ₂ i ₁ i ₀	2	2	EDIH ← (EDIH) ∨ i4	Sets the Interrupt enable flag.	
	EIL i4	Enable interrupt low	1 1 0 0 0 1 0 0	1 1 0 1 i ₃ i ₂ i ₁ i ₀	2	2	EDIL ← (EDIL) ∨ i4	Sets the Interrupt enable flag.	
	DIH i4	Disable interrupt high	1 1 0 0 1 0 0 1	1 1 0 1 i ₃ i ₂ i ₁ i ₀	2	2	EDIH ← (EDIH) ∧ $\bar{i}4$	Resets the interrupt enable flag.	ZF
	DIL i4	Disable interrupt low	1 1 0 0 1 0 0 0	1 1 0 1 i ₃ i ₂ i ₁ i ₀	2	2	EDIL ← (EDIL) ∧ $\bar{i}4$	Resets the interrupt enable flag.	ZF
	WTSP	Write SP	1 1 0 0 1 1 0 1	1 1 1 1 1 0 1 0	2	2	SP ← (E), (AC)	Transfers the contents of the E register and accumulator (AC) to the stack area.	
	RSP	Read SP	1 1 0 0 1 1 0 1	1 1 1 1 1 0 1 1	2	2	E, AC ← (SP)	Transfers the contents of the stack area to the E register and accumulator (AC).	
Standby control instructions	HALT	HALT	1 1 0 0 1 1 0 1	1 1 1 1 1 1 1 0	2	2	HALT	Selects the HALT mode.	
	HOLD	HOLD	1 1 0 0 1 1 0 1	1 1 1 1 1 1 1 1	2	2	HOLD	Selects the HOLD mode.	
Serial I/O control instructions	STARTS	Start serial I/O	1 1 0 0 1 1 1 0	1 1 1 1 1 1 1 0	2	2	START SIO	Starts the SIO operation mode.	
	WTSIO	Write serial I/O	1 1 0 0 1 1 1 0	1 1 1 1 1 1 1 1	2	2	SIO ← (E), (AC)	Writes the contents of the E register and accumulator (AC) to the SIO register.	
	RSIO	Read serial I/O	1 1 0 0 1 1 1 1	1 1 1 1 1 1 1 1	2	2	E, AC ← (SIO)	Reads the contents of the SIO register into the E register and the accumulator (AC).	
Other instructions	NOP	No operation	0 0 0 0 1 1 0 0	0 0 0 0 0 0 1 0	1	1	No operation	A dummy instruction that is coded 00H and has no effect when executed. Just one machine cycle signal reaches the CPU.	
	SB i2	Select bank	1 1 0 0 1 1 0 0	1 1 1 1 0 0 1 0	2	2	PC13, PC12 ← i ₁ i ₀	Selects memory banks.	Usable only on LC66599, LC66PG5XX

DISCONTINUED